



9" Swivel Portable DVD Player with Digital TV Tuner and USB/SD/MMC inputs

MODEL NO.:NPDT-951



INSTRUCTION MANUAL



**BEFORE USING THIS PRODUCT, READ, UNDERSTAND,
AND FOLLOW THESE INSTRUCTIONS.
Save this booklet for future reference.**

TROUBLESHOOTING (CONTINUED)

Symptom [DVD]	Remedy
Play does not start even when title is selected.	Confirm the region code setting is right.
Audio soundtrack and/or subtitle language is not the initial settings.	If the audio soundtrack and/or subtitle language does not exist on the disc, the language selected at the initial settings will not be seen/heard.
No subtitles.	<ul style="list-style-type: none"> ● Subtitles appear only with discs which contain them. ● Subtitles are cleared from the TV monitor, Perform the steps display the subtitles.
Alternative audio soundtrack (or subtitle) languages fail to be selected.	<ul style="list-style-type: none"> ● An alternative language is not selected with discs which do not contain more than one language. ● In the case of some discs, the alternative language can not be selected by operating the AUDIO or SUBTITLE button. Try selecting it from the DVD menu if one is available.
Angle cannot be changed.	This function is dependent on software availability. Even if a disc has a number of angles recorded, these angles may be recorded for specific scenes only.
The password for rating level has been forgotten.	Please contact your local sales dealer.
Symptom [Video CD]	Remedy
No menu play.	This function works only for Video CDs with playback control.
Symptom [TV]	Remedy
No or poor picture	<ul style="list-style-type: none"> ● Adjust antenna or use an external antenna ● Relocate the unit near a window (if inside a building) ● Use an external antenna ● Move unit away from equipment that causes interference ● Ensure antenna/cable connection is secure ● Auto Scan for channels again ● Try another channel
No sound or poor sound quality	<ul style="list-style-type: none"> ● Check the speaker settings. Turn up the volume. ● Press MUTE on the remote control to cancel the mute function ● Unplug the headphones
Noise or other interference	<ul style="list-style-type: none"> ● Electronic equipment near the unit is causing interference. Relocate the unit or move the equipment.

REGION CODE SETTING

Region coding: All DVD discs are coded by the sales territory. Please note the player is set to region 1 coding by the factory which cannot be changed. This is in compliance with the DVD patent requirements.

The region number for this DVD player is



SPECIFICATIONS

Power requirements:

AC 100 -240V~ 50/60Hz

Power source:

AC adaptor (normal: DC12V)

Power consumption: ≤18W

Resolution:640 RGB *234

Dots Distance:0.30975x0.4775mm

Visible Range:198.240x111.735mm

Discs played:

(1) DVD-VIDEO disc

- 12 cm single-sided,single-layer
- 12 cm single-sided,dual-layer
- 12 cm double-sided,single-layer
- 8 cm sinle-sided,single-layer
- 8 cm single-sided,dual-layer
- 8 cm double-sided,single-layer

(2) Compact disc(VIDEO CD)

- 12 cm disc
- 8 cm disc

Video output level: 1 V_{p-p}

Audio output level: 1.2V

Earphone output level:

(1KHz , 0dB, 1.25mW)

Pickup: Wave length: 655nm

Laser power: CLASS-1

Operating Temperature Range:

-5°C to 45°C

Operating Humidity Range: 0% to 80%

Measurement: 238 x 192 x 41mm

Weight: Approx. g

Specifications are subject to change without notice.

TROUBLESHOOTING

Before requesting service for this player, check the chart below for a possible cause of the problem you are experiencing. Some simple checks or an adjustment on your part may eliminatethe problem and restore proper operation.

Symptom(Common)	Remedy
No power.	Insert the AC adaptor securely into the power outlet.
<ul style="list-style-type: none"> ● Play fails to start even when PLAY is pressed. ● Play starts but then stops immediately. 	<ul style="list-style-type: none"> ● Condensation has formed: wait about 1 to 2 hours to allow the player to dry out. ● This player cannot play a disc other than DVD, VCD and CD. ● The disc may be dirty and may require cleaning. ● Ensure that the disc is installed with the label side up.
No picture.	Ensure that the equipment is connected properly.
<ul style="list-style-type: none"> ● No sound. ● Distorted sound. 	<ul style="list-style-type: none"> ● Ensure that the equipment is connected properly. ● Ensure that the input setting for the TV and stereo system are correct.
Picture is distorted during rapid advance or rapid reverse.	The picture will be somewhat distorted at times: this is normal.
No rapid advance or rapid reverse play	Some discs may have sections which prohibit rapid advance (or rapid reverse.)
No operations can be performed with the remote control unit.	<ul style="list-style-type: none"> ● Check the batteries are installed with the correct polarities. ● The batteries are exhausted: replace them with new ones. ● Point remote control at the remote control sensor and operate. ● Operate the remote control unit at a distance of not more than 6 m from the remote control sensor. ● Remove the obstacles between the remote control and remote control sensor.
No key operation (by the main unit and/or the remote control unit) is effective.	Press POWER to set the player to the standby mode and then back to ON. Alternatively, press POWER to set the player to the standby mode, disconnect the power adaptor and then reconnect it. (The player may not be operating properly due to lightning, static electricity or some other external factor.)

SAFETY INFORMATION

CAUTION:

DVD/VIDEO CD/CD PLAYER IS A CLASS 1 LASER PRODUCT. HOWEVER THIS DVD/ VIDEO , CD/CD PLAYER USES A VISIBLE LASER BEAM WHICH COULD CAUSE HAZARDOUS RADIATION EXPO SURE IF DIRECTED. BE SURE TO OPERATE THE DVD/VIDEO CD/CD PLAYER CORRECTLY AS INSTRUCTED.

WHEN THIS DVD/VIDEO CD/CD PLAYER IS PLUGGED TO THE WALL OUTLET, DO NOT PLACE YOUR EYES CLOSE TO THE OPENING OF THE DISC TRAY AND OTHER OPENINGS TO LOOK INTO THE INSIDE OF THIS PLAYER.

USE OF CONTROLS OR ADJUSTMENTS OR PERFORMANCE OF PROCEDURES OTHERTHAN THOSE SPECIFIED HEREIN MAY RESULT IN HAZARDOUS RADIATION EXPOSURE.

DO NOT OPEN COVERS AND REPAIR YOURSELF. REFER SERVICING TO QUALIFIED PERSONNEL

THIS DEVICE IS INTENDED FOR CONTINUOUS OPERATION!

TO REDUCE THE RISK OF FIRE OR ELECTRIC SHOCK, AND ANNOYING INTERFERENCE, USE THE RECOMMENDED ACCESSORIES ONLY.

WARNING:

-TO PREVENT FIRE OR SHOCK HAZARD. DO NOT USE THIS PLUG WITH AN EXTENSION CORD. RECEPTACLE OR OTHER OUTLET UNLESS THE BLADES CAN BE FULLY INSERTED TO PREVENT BLADE EXPOSURE.
-TO PREVENT FIRE OR SHOCK HAZARD. DO NOT EXPOSE THIS APPLIANCE TO RAIN OR MOISTURE.

CAUTION - LASER RADIATION WHEN OPEN, DO NOT STARE INTO BEAM.

VENTILATION WARNING - THE NORMAL VENTILATION OF THE PRODUCT SHALL NOT BE IMPEDED FOR INTENDED USE.



The lightning flash and arrow head within the triangle is a warning sign alerting you of dangerous voltage inside the product.

CAUTION
RISK OF ELECTRIC SHOCK
DO NOT OPEN

CAUTION: TO REDUCE THE RISK OF ELECTRIC SHOCK. DO NOT REMOVE COVER (OR BACK). NO USER SERVICEABLE PARTS INSIDE. REFER SERVICING TO QUALIFIED SERVICE PERSONNEL.



The exclamation point within the triangle is a warning sign alerting you of important instructions accompanying the product.

Always follow basic safety precautions when using electrical products, especially when children are present.

WARNING: To avoid the risk of electrical shock, make sure the product is unplugged from the electrical outlet before relocating, servicing, or cleaning it.

Read all instructions before using

- Do not use this product near water.
- Do not ceiling- or wall-mount the product.
- Install the product in accordance with the operating instructions.
- Do not set the product near heat sources, such as radiators, heat registers, stoves, or other apparatus (including amplifiers) that produce heat.
- Protect the power cord from being walked on or pinched, particularly at plugs, convenience receptacles, and the point where they exit the product.
- Do not use attachments not recommended or sold by the product manufacturer as a risk of fire, electrical shock, or serious personal injury may result.
- Unplug the product during lightning storms or when unused for long periods of time.
- Do not expose the product to dripping or splashing water. Do not place objects filled with liquid (e.g., vases) on the product.
- Do not place in or expose the product to direct sunlight, extreme heat, humid or dusty locations.
- Never operate this product if it has a damaged power cord or plug, is not working properly, has been dropped, damaged, or exposed to moisture, water, or other liquids. Do not attempt to examine or repair this product yourself; take the product to a service centre for inspection and repair.
- Keep magnetic objects such as speakers, at a distance from the player.

LASER SAFETY



This set employs an optical laser beam system in the CD mechanism designed with built-in safeguards. Do not attempt to disassemble. Exposure to this invisible laser light beam may be harmful to the human eye. This is a Class-1 laser product. Use of controls, adjustments or procedures other than those specified herein may result in hazardous laser light beam exposure. This compact disc player should not be adjusted or repaired by anyone except qualified service personnel. The laser mechanism in the set corresponds to the stylus (needle) of a record player. Although this product uses a laser pick-up lens, it is completely safe when operated according to directions.

NOTE: The manufacturer is not responsible for any radio or TV interference caused by unauthorized modifications. Such modifications could void the user's authority to operate the equipment.

- 1) Operate turning controls and switches as instructed in the manual.
- 2) Before turning on the power for the first time, make sure that the power cord is properly installed.
- 3) Store your discs in a cool area to avoid damage from heat.

Battery Handling and Usage

NOTE: This style player contains rechargeable Lithium battery . There is a CR 2025 battery for remote control.

- 1). Never throw batteries into a fire. Do not expose batteries to fire or other heat sources.
- 2). Battery Disposal: Spent or discharged batteries must be properly disposed of and recycled in compliance with all applicable laws. For detailed information, contact your local solid waste authority.

DISC HANDLING AND MAINTENANCE

Handling precautions

- Hold the disc by the edges so the surface will not be soiled with fingerprints. Fingerprints, dirt and scratches can cause skipping and distortion.
- Do not write on the label side with a ball-point pen or other writing utensils.

DEFINITION OF TERMS

DVD

This refers to a high-density optical disc on which high-quality pictures and sound have been obtained by means of digital signals. Incorporation a new video compression technology (MPEG II) and high-density recording technology, DVD enables aesthetically pleasing full-motion video to be recorded over long periods of time (for instance, a whole movie can be recorded). DVD has a structure consisting of two 0.6 mm thin discs which are adhered to each other. Since the thinner the disc, the higher the density at which the information can be recorded, a DVD disc has a greater capacity than a single 1.2 mm thick disc. Since the two thin discs are adhered to each other, there is the potential to achieve double-sided play sometime in the future for even longer duration play.

Video CD

This contains recordings of pictures and sound whose quality is on a par with that of video tape. This player also supports Video CDs with playback control (version 2.0).

Mp3

These contain recordings of music which are compressed, allowing a significantly larger amount of music to be stored on a CD.

Angle

Recorded onto some DVD discs are scenes which have been simultaneously shot from a number of different angles (the same scene is shot from the front, from the left side, from the right side, etc.). With such discs, the ANGLE button can be used to view the scene from different angles.

Subtitles

This is the appearance of the dialogue at the bottom of the screen which are prerecorded on some DVD discs.

Title number

These numbers are recorded on DVD discs. When a disc contains two or more movies, these movies are numbered as title 1, title 2, etc.

Chapter number

These numbers are recorded on DVD discs. A title is sub- divided into many sections, each of which is numbered, and specific parts of video presentations can be searched quickly using these numbers.

Time number

This indicates the play time which has elapsed from the start of a disc or a title. It can be used to find a specific scene quickly.(It may not work with some discs.)

Playback control (PBC)

This is recorded on a Video CD (version 2.0). The scenes or information to be viewed (or listened to) can be selected interactively with the TV monitor by looking at the menu shown on the TV monitor.

Track number

These numbers are assigned to the tracks which are re- corded on Video CDs and CDs. They enable specific tracks to be located quickly.

6 SYSTEM SETUP

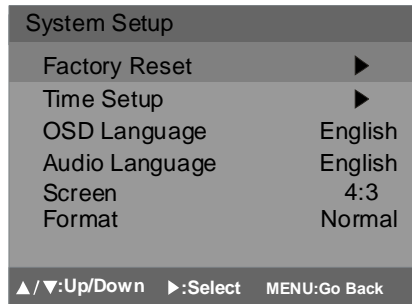

6.1 FACTORY RESET

- It is used to reset to factory settings.
- Press up/down button to select this item, then press right button to enter.

6.2 TIME SETUP

- 6.2.1 Clock
 - The Clock displays the current time from programs.(this option is not user adjustable)
- 6.2.2 Time Zone
 - To set the time zone: Eastern, Samoa, Hawaii, Alaska, Pacific, Mountain, Central, Atlantic and Newfoundland.
- 6.2.3 Daylight Saving
 - it is used to set daylight saving time.
 - Press up/down button to select it,then press left/right to set it ON/OFF.

6.3 OSD LANGUAGE

- Press up/down button to select this item,then press left/right button to change the OSD language.
- Option:English or other languages.It depends on the software.

6.4 AUDIO LANGUAGE

- It is used to set the audio language.
- Press up/down button to select it, then press left/right button to select the language as desired.

6.5 SCREEN

- It is used to select screen display mode.
- Press up/down button to select this item,and press left/right button to change the mode.
- Option:4:3/16:9

6.6 FORMAT

- It is used to select the format mode.
- Option:Normal

- Do not use record cleaning sprays, benzine, thinner, static electricity prevention liquids.
- Be careful not to drop or bend the disc.
- Do not install more than 1 disc on the disc compartment.
- Do not try to close the disc cover when the disc is not installed properly.
- Be sure to store the disc in its exclusive case when not in use.

If the surface is soiled

Wipe gently with a soft, damp (water only) cloth.
When wiping discs, always move the cloth from the centre hole toward the outside, which will not cause distortion. (If you wipe the discs using a circular motion, circular scratches are likely to occur, which will cause distortion.)

If the disc is brought from a cold to a warm environment moisture may form on the disc

Wipe this moisture off with a soft, dry, lint-free cloth before using the disc.

Improper disc storage

You can damage discs if you store them in the following places:

- Areas exposed to direct sunlight
- Humid or dusty areas
- Areas directly exposed to a heat outlet or heating appliance

Maintenance

- Be sure to press POWER to set the player to the standby mode and disconnect the AC adaptor before maintaining the player.
- Wipe the player with a dry, soft cloth.
- If the surfaces are extremely dirty ,wipe clean with a cloth which has been dipped in a weak soap-and-water solution and wrung out thoroughly, and then wipe again with a dry cloth.
- Never use alcohol, benzine, thinner, cleaning fluid or other chemicals. And do not use compressed air to remove dust

ACCESSORIES



Remote control
with battery
.....1



Car cord
.....1



Instruction
manual
.....1



AC adaptor
.....1



Audio/Video
cable1



Antenna
convertor
.....1

All the pictures in the instruction manual are just for your reference, specification should refer to actual accessories.

TABLE OF CONTENTS

Getting Started:

Safety information.....	1-2
DISC handling and maintenance	2-3
Accessories.....	3
Features	5
Control reference guide	6-7
Basic connection.....	8-9
Remote control preparation.....	10

DVD Operations:

Basic play.....	11
Stopping play.....	12
Skipping ahead or back.....	12
Fast forward/backward.....	12
Pause or play.....	12
Slow-motion play(DVD/VCD).....	13
MP3 playback.....	13
MP4 playback.....	14
CARD playback.....	15
USB	16
JPEG CD.....	17-18
Enjoying Video CD with playback control.....	18
On screen display information.....	19
Program play.....	19
Repeat play.....	20
TFT MODE	20
GO TO.....	20
Changing subtitle language(DVD Only).....	21
ZOOM.....	21
Changing audio soundtrack language [DVD/VCD disc].....	21
Initial settings.....	22-24
General setup.....	22-23
Audio setup.....	24

TV Operations:

Turn on the unit.....	25
Antenna operation.....	25
Basic operations.....	25-26
TV menu control.....	26
Main menu.....	27-30

For Reference:

Definition of terms.....	31
Specifications.....	32
Troubleshooting.....	32-33
Region code setting.....	33

5.PROGRAM CONTROL SETUP

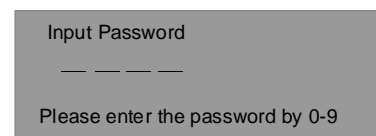

-Press up or down button to select this item, and press right button to enter INPUT PASSWORD page, Input 0000(In this unit, the original password is 0000) to enter **PROGRAM CONTROL** page as above. These setting allow certain people to view certain channels, which may be especially useful to forbid children from viewing some unbecoming channels.

5.1 V-CHIP SETTING

-Press right button to enter this sub-menu.

5.1.1 Movie Ratings

-Press right button enter MOVIE RATINGS sub-menu.

-Press up/down button to select item as desired and press OK button to set it.

-Option: G,PG,PG-13,R,NC-17,X and Y.

5.1.2 USA TV Content Ratings

-Press right button enter this sub-menu.

-Press up/down button to select item as desired and press OK button to set it.

-Option:Y,Y7,G,PG,14 and MA.

5.1.3 Canada English Ratings

-Press right button enter this sub-menu.

-Press up/down button to select item as desired and press OK button to set it.

-Option:C,C8+,G,PG,14+ and 18+.

5.1.4 Canada French Ratings

-Press right button enter this sub-menu.

-Press up/down button to select item as desired and press OK button to set it.

-Option:G,8ans+,13ans+,16ans and 18ans.

5.2 RRT SETTING

-Press up/down button to select this item and press right button to enter.

5.3 BLOCK ENABLE

-Press up/down button to select this item and press left/right button to set it ON or OFF.

5.4 UNRATED

-Press up/down button to select this item and press left/right button to set it ON or OFF.

5.5 CHANGE PASSWORD

-It is used to change the password, and the procedure of changing password is described as follows:

Enter new password in the NEW PASSWORD row, after that the system will require you to confirm the new password. Then enter the new password again in the CONFIRM PASSWORD row.If success,message 擘 hange Password Success!摎 ill appear in the screen.

NOTE: The original password is 0000, you can change it, but you should write it down and keep it safe. If you forget the password, please contact with the supplier.

2.2 SKIP

-Press up or down button to select skip item, then press left or right button to select on or off .
ON: If SKIP is ON, channel number what you select will be skipped when selecting channel using the CH- or CH+ button.

OFF: If SKIP OFF, all the channel numbers(the channels are stored in the unit)can be accessed using CH- or CH+ button.

Skip/unskip a channel:

1.Press up/down button to select CHANNEL item, then press left/right button to select the channel backward/forward you want to skip.

2.Press up/down button to select the SKIP item in channel setup menu and press left/right button to skip current channel or not.

2.3 FAVORITE LIST

-Press up or down button to select this item, then press right button to get in the favorite list page.

-You can set maximum five favorite channels. Press up or down button to select item then press left/right button to set the channel is your favorite channel or not.

3.CC SETUP

CC Setup	
CC Display	Off
608CC Type	C1
708CC Type	Service 1
CC Mode	Customer
CC Customer	▶
▲/▼:Up/Down ▶:Select MENU:Go Back	

3.1 CC DISPLAY

-Press up or down button to select it and press left or right button to set the cc display ON or OFF.

3.2 608CC TYPE

-Press up or down button to select this item, and press left or right button to change the cc type .

-Option:C1/C2/C3/C4/T1/T2/T3/T4

3.3 708 CC TYPE

-Press up or down button to select this item, and press left or right button to change the cc type.

-Option:Service1/Service2/Service3/Service4/Service5/Service6

3.4 CC MODE

-Press up or down button to select this item, and press left or right button to change the cc mode.

-Option: Broadcast/Customer

-If you select CUSTOMER, There will appear CC CUSTOMER item, select this item and press right button to enter, you can set what you want to, such as font,color,etc.

4.EAS SETUP

EAS Setup	
<input checked="" type="checkbox"/>	Always
<input type="checkbox"/>	Skip low priority
<input type="checkbox"/>	Skip low/medium priority
▲/▼:Up/Down OK:Select MENU:Go Back	

-This system can display EAS(Emergency Alert System)message broadcast pursuant to 47CFR11.117 of the FCC Rules.

-Press up or down button to select this item, and press right button to enter.

-Option:always, skip low priority and skip low/medium priority

-Press up or down button to select what you desire and press OK/ENTER button to confirm, then there will be a ✓ icon in the frame. Press OK/ENTER button again, the icon will disappear.

FEATURES

9" TFT DISPLAY

This player has a built-in 9 TFT display window, to provide clear vision, and low radiation.

WITH RECHARGEABLE LITHIUM BATTERY

COMBINATION OF TV/DVD PLAYER

Press SWITCH button to switch the unit in TV or DVD mode as you want to.

MULTI TV SYSTEM SUPPORT

The player can play discs with signal system of PAL and NTSC.

GRAPHICAL USER INTERFACE SCREEN

Simply by pressing the OSD button on the remote control, information on the player and disc can be displayed on the screen for easy identification, The player's operations and settings can be performed by operating the remote control while monitoring screen.

AUTO TV SCANNING FUNCTION

FULL FUNCTION REMOTE CONTROL

SUPPORT VIDEO/AUDIO OUTPUT

MULTI-AUDIO FUNCTION

The audio soundtrack can be heard in up to 8 languages. (The number of audio sound languages depends on the software.)

MULTI-SUBTITLES FUNCTION

Subtitles may be displayed in one of a maximum of 32 languages depending on the software.

ROTATABLE SCREEN

The screen can be rotated from 0° to 180° clockwise or 0° to 90° anti-clockwise for providing multi-angle of view; then the screen can be folded to lap over the main unit.



Note:

Rotate the screen only when the player is off!

We will not respond the situation that damage due to incorrect rotating.

USB /CARD READER FUNCTION

This player can play USB /CARD containing files in VCD/ SVCD/ DVD/ Mp3 /WMA/ MPEG4/ JPEG /CD format.

(NOTE: The USB port of this unit cannot connect with the removable HDD.)

CONTROL REFERENCE GUIDE

Main unit

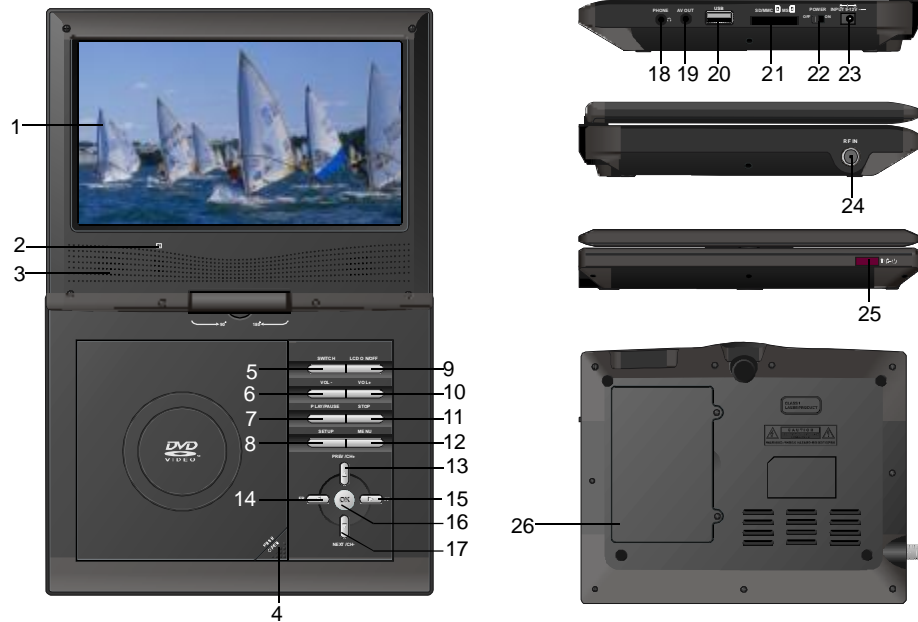

- 1 TFT Display Window-** Displays all information about DVD/TV work scene.
- 2 Remote control sensor**
- 3 Built-in Speaker**
- 4 OPEN button-** Press this button to open the disc cover.
- 5 SWITCH button-** Press this button to set the player between DVD and TV mode.
- 6 VOLUME - button-** Press this button to turn down the volume.
- 7 PLAY/PAUSE button-** Press this button to start or pause playing a disc.
- 8 SETUP button-** Press this button to enter DVD initial settings menu(in DVD mode).
- 9 LCD ON/OFF-** Press this button to turn on or turn off the lcd screen.
- 10 VOLUME + button-** Press this button to turn up the volume.
- 11 STOP button-** Press this button to stop playing.
- 12 MENU button-** In DVD mode, press it to return to the root menu(for DVD) or to turn on/off the PBC (for VCD).In TV mode,press it to enter TV settings menu page.
- 13 PREV/CH+ button-** Press this button to up, and in DVD mode, if you keep pressing it for more than 2 seconds, the player will skip to the previous chapter or title(for DVD)or track (for CD).In TV mode, press this button to play the next channel.

- 14 LEFT/ FR button-** Press LEFT button to left, and if you keep pressing it for more than 2 seconds, the player will play the disc backward at speed:x2,x4,x8, x16,x32.
- 15 RIGHT/FF button-** Press RIGHT button to right, and if you keep pressing it for more than 2 seconds, the player will play the disc forward at speed:x2,x4, x8,x16,x32.
- 16 OK button-** Press this button to confirm an operation.
- 17 NEXT/CH- button-** Press this button to down, and in DVD mode, if you keep pressing it for more than 2 seconds, the player will skip to the next chapter or title(DVD) or track (for CD).In TV mode,press this button to play the previous channel.
- 18 Phone-** Connect headphone to this jack for share listening.
- 19 AV OUT Jack-** Connect TV or other external AV equipment to this jack to use the unit as a signal source.
- 20 USB slot**
- 21 SD/MMC/MS card slot**
- 22 Power Switch-** Switch this knob to turn on/off the unit.
- 23 DC In Jack-** Power input jack.
- 24 External Antenna Jack-** When the signal is too weak, connect a external antenna to this jack for a better reception.
- 25 CHARGE INDICATOR, Power ON / Standby Indicator**
- 26 BATTERY COVER**

MAIN MENU

Common procedure for initial settings

- 1.Press MENU button.
- 2.Use the UP or DOWN button to select preferred page, then press RIGHT button to enter. Each page for setting the value will display. Then move the up or down button to select item and use left or right button to set.
- 3.Press MENU button again to return to previous menu setting page.

Press MENU button to enter tv MAIN MENU page as follows:

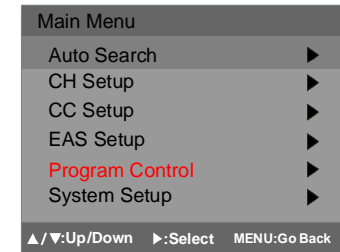

1.AUTO SEARCH



1.1 SOURCE TYPE

It is used to set the source type.

- Press up or down button to select it and then press left or right button to set.
- Options: Antenna/Cable.

1.2 START SEARCH

Before normal watching you must search effective channel first.

- Press up or down button to select it and press RIGHT button to get in scanning setup page.
- Press LEFT or EXIT button to cancel the auto scan.

1.3 SNR

This option is not user adjustable.

2.CH SETUP

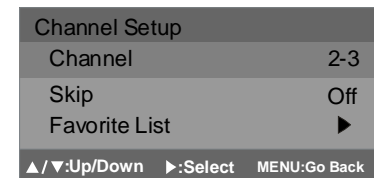

2.1 CHANNEL

- Press up or down button to select it and then press left or right button to change the channel number.

CC

It is used to set the caption mode.

-Keep pressing CC button to select different mode as desired.

-Option:On/Off

INFO(INFORMATION)

It is used to display current program information.

-Press INFO button, the screen will display as below:

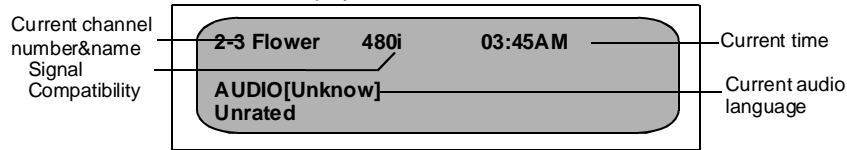

EPG (Electronic program guide)

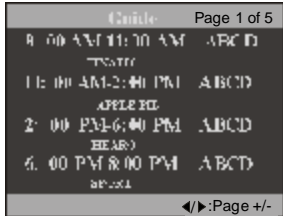

When viewing a digital channel, press the EPG Button to access the program guide supplied by the signal provider (not available in all areas).

Press the LEFT/RIGHT button to access previous/next page in program scheduler.

TFT MODE

Press TFT/TV MENU button, the screen will display:

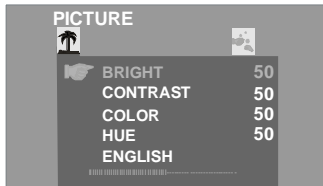

NOTE:The level of BRIGHT, CONTRAST, COLOR and HUE can be adjusted 0-100. The menu language can be changed among multi-languages.

1.Move the UP or DOWN navigation button to select BRIGHT, CONTRAST, COLOR, HUE, or ENGLISH item,then press the LEFT or RIGHT navigation button to adjust the level of the selected item.

2.Press TFT/TV MENU button again to enter OPTION page. Press UP or DOWN navigation button to select NORMAL or ZOOM item. Then press the LEFT or RIGHT navigation button to adjust. The NORMAL item can be adjusted between NORMAL and DOWN mode(to switch the picture between normal and vertical mode). And the ZOOM can be set to 16:9 or 4:3 mode.

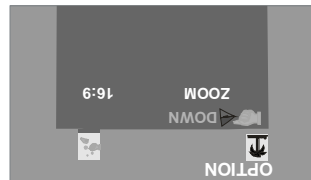
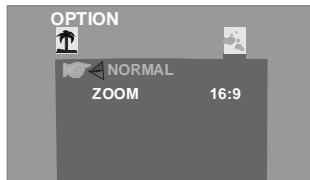

3.Press TFT/TV MENU button again to exit this page.

CONTROL REFERENCE GUIDE

Remote control

1.**MUTE** -To mute the sound.

2.**INVERSION button** -Press this button to inversion the picture which played.

3.**NUMERIC buttons** -To input the numeric information, such as track number, channel number and so on.

4.**FF button** -Press this button to play the disc forward at speeds: x2,x4,x8,x16,x32(in DVD mode).

5.**FR button** -Press this button to play the disc backward at speeds:x2,x4,x8,x16,x32(in DVD mode).

6.**SLOW button** -Press this button to play the disc at speeds:1/2,1/4,1/8,1/16.

7.**ZOOM button** -Press this button to enlarge picture size, max.to X 4 or to shrink picture size, min. to X1/4.

8.**ANGLE button** -Press this button to display the angle number and change to different angles.

9.**PROGRAM button** -Press this button to setup the memory order of chapter or title (for DVD) or tracks (for VCD/CD).

10.**TFT/TV MODE button** -Press this button to enter TFT/TV mode page.

11.**TITLE button** -Press this button to return to title menu (for DVD).

12.**SUBTITLE button** -Press this button to display and change subtitle language(for DVD only).

13.**AUDIO button** -To select the audio mode(in DVD mode).

14.**SWITCH button** -To switch the mode between TV and DVD mode.

15.**INFO** -To display current program information, such as channel number, soundtrack mode, subtitle language and so on(only for TV mode).

16.**EPG** -Display the program information of current day or latter days(only for TV Mode).

17.**STANDBY** -To set the unit in standby mode or switch the unit on.

18.**DISP button** -Press DISP button continuously during playback, the screen will display the playing information, such as elapsed time, remaining time and so on(in DVD mode).

19.**N/P button** -Press this button to select NTSC or PAL system (for DVD only).

20.**GO TO button** -Press this button to set the player to play disc starting at a certain point.

21.**STOP button** -Press this button to halt playing.

22.**PLAY/PAUSE button** -Press this button to start or pause playing the disc.

23.**PREV button** -Press this button to play the previous chapter (for DVD) or track (for VCD/CD).

24.**NEXT button** -Press this button to play the next chapter(for DVD) or track(for VCD/CD).

25.**A-B button** -Press this button to repeat playing sections between two specific points (A-B).

26.**REPEAT button** -Press this button to repeat playing one chapter or one title (forDVD) or repeat playing the current track or the whole tracks (for VCD/CD).

27.**CH+/UP** -To move up or select program forward.

28.**SETUP button** -Press this button to enter DVD initial settings menu (in DVD mode).

29.**ENTER button** -Press this button to confirm what you have selected.

30.**Navigation buttons** -Press this button to move up, down, left or right.

31.**CH-/DOWN** -To move down or select program backward.

32.**MENU button** -Press this button to enter main menu page(in DVD mode) or to enter TV settings menu(in TV mode).

33.**VOLUME - button** -Press this button to turn down the volume.

34.**VOLUME + button** -Press this button to turn up the volume.

35.**CC** -To set the caption mode(only for TV mode).

36.**EXIT** -To exit the menu page(only for TV mode).

37.**USB/CARD/DVD button** -To switch the mode among USB/CARD/DVD mode.

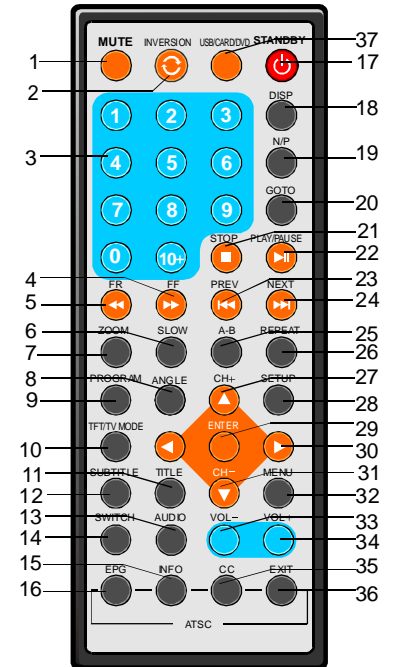

BASIC CONNECTION

- Ensure all the cables are disconnected from the main unit before connecting to AC power source .
- Read through the instructions before connecting other equipment.

Connecting to AC power source

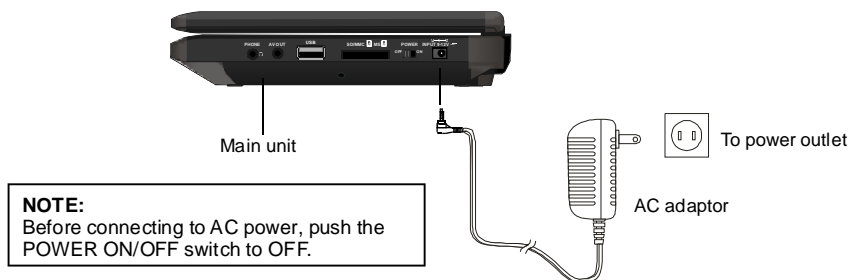

Rechargeable Battery Use

The player built-in a chargeable Lithium battery.

1.Charge the battery

-Connect the adaptor to the DC 12V IN jack, then set the unit in POWER ON mode (THE PLAYING MODE)for fully charge.

-Set in POWER ON mode and press the STANDBY button (THE STANDBY MODE) or set in POWER OFF mode for fully charge.

And the indicator is red during charging; it gets green when charging is completed.

2.Time to recharge the battery

Charge the built-in battery pack 8 hours before using the player for the first time.

Recharge and playback time depends on battery pack capacity and the temperature condition. Generally speaking, The battery needs to be charged about 4 hours.

3.Using and Maintaining Rechargeable Battery

-.The normal working condition temperature is: 0 ~45 °C ;

-.Always unplug AC/DC power supply for the unit whenever not playing.

NOTE: A new battery pack which has not been used or one which has not been used for more than a month, may appear to not recharged enough , this is due to the characteristic of this battery and is not a malfunction. In this case, recharge it two or three times before the first use, and it needs more than 8 hours to recharge battery.
Noises may be generated during recharging. In this case, use a more distant power socket.
Do not recharge or discharge battery near a heating element such as a heater or direct sunlight.

TV OPERATIONS

TURN ON THE UNIT

1. Push POWER switch at the right side of the unit to turn on the unit.
2. Press SWITCH button to set the unit in TV mode.

ANTENNA OPERATION

EXTERNAL ANTENNA

Install external antenna into antenna jack for best reception.

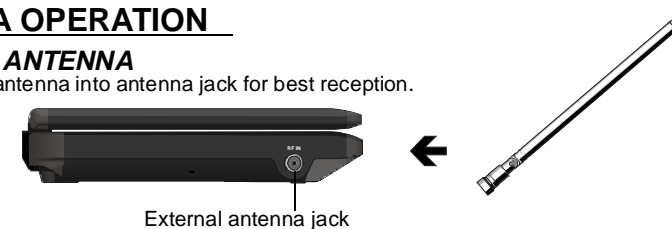

BASIC OPERATIONS

AUTO SEARCHING

Before normal watching you must search effective channels first.

-Press MENU button on remote control, the screen will display:

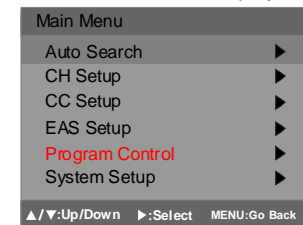

-Select AUTO SEARCH item, press right button to enter this item.

-Set the SOURCE TYPE what you want. Select START SEARCH item then press right to start to search channels automatically. Wait for several minutes until searching finished, then the first searched channel will be played.

NOTE:You must do auto search again after different system selection according to your area.

SELECT WANTED PROGRAM

1. Press CH + button to enter next channel.

2. Press CH - button to enter previous channel.

3. Press numeric buttons on the remote control directly to select program what you want.

Example: Track 9, press "9" three seconds later, it will automatically switch to track 9, or press ENTER button to confirm directly.

Track 12,press "1" and "2", three seconds later, it will automatically switch to track12,or press ENTER button to confirm directly.

Note: If one frequency dot has more than one channel, for example, you want select <CH 14 NO.2>, Press 1 and 4, then press right navigation button and input 2.Press ENTER button to confirm. Once the input is done, it will start broadcasting the selected channel immediately.

VOLUME CONTROL

1. Press the VOL+ or VOL- to adjust the level of currently volume.

2.The level of VOLUME can be adjust from 0-40.

MUTE CONTROL

Press the MUTE button to mute the sound, press it again to switch ON the sound.

NOTE: When the unit is in Mute mode, pressing VOL+ button will switch ON the sound and turn it up, pressing VOL- button will switch ON the sound and turn it down.

2. AUDIO SETUP

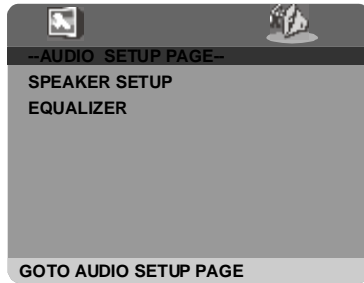

2.1 Speaker setup-It is to set the speaker output levels

Options:LT/RT -Left/Right mix mode.

STEREO-Select this option if you do not have a 2.1 channel amplifier

V SURR -surround -It is used to set dummy surrounding audio effectiveness.

2.2EQUALIZER SETUP - It is used to compensate for frequency distortion to improve its frequency response in audio systems(not applicable).

Options: EQ TYPE. In this option you can choose different EQ TYPE.

BASS BOOST. In this option you can set it to ON or OFF

SUPER BASS: In this option, you can set it to On or OFF.

TREBLE BOOST: In this option,you can set it to On or OFF

Connecting to TV set

To video input connector (yellow)
To audio input connectors (red, white)

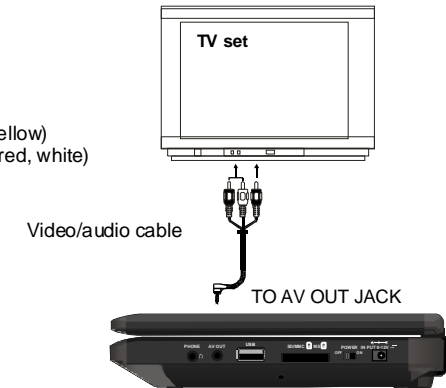

Connecting to external signal sources

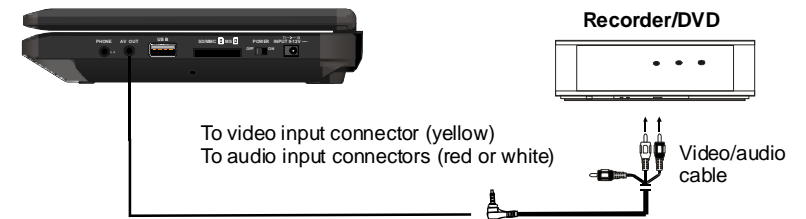

Connecting to audio equipment

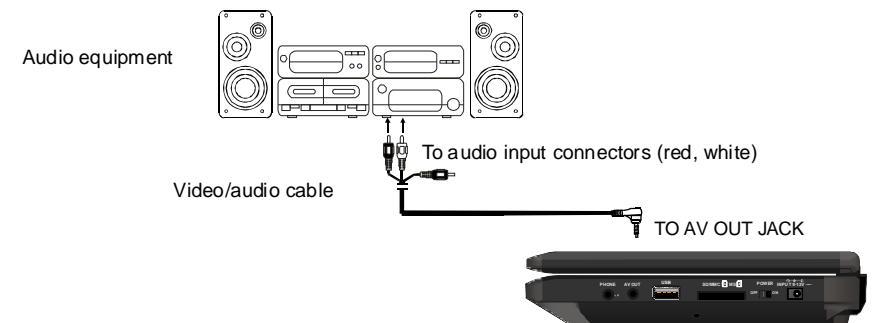

Connect headphone

1. Connect the headphone.

Adjust the volume to minimize the volume.

Connect the headphone to phone jack.

2. Adjust the volume to the level that you want.

REMOTE CONTROL PREPARATION

Battery installation

Insert the battery while observing the correct (+) and (-) polarities as illustrated at right(Fig 1).

Service life of battery

- The battery normally last for about one year although this depends on how often the remote control is used.
- If the remote control fails to work even when it is operated near the player, replace the battery.
- Use one type CR2025 battery.

Note:

- Do not use rechargeable (Ni-Cd) battery.
- Do not attempt to recharge, short-circuit, disassemble, heat or throw the batteries into the fire.
- Do not drop, step on or otherwise impact the remote control. This may damage the parts or lead to malfunction.
- If the remote control is not going to be used for a long time, remove the battery.

Remote control operation

1. Remove the protective plastic tab before operating the remote control.
2. Keep the remote control from no more than 6m from the DVD player and within about 60° of the front of the player (Fig 2).

NOTE:The operating distance may vary according to the brightness of the room.

- Do not point bright lights at remote control sensor.
- Do not place objects between the remote control and the remote control sensor.
- Do not use this remote control while simultaneously operating the remote control of any other equipment.

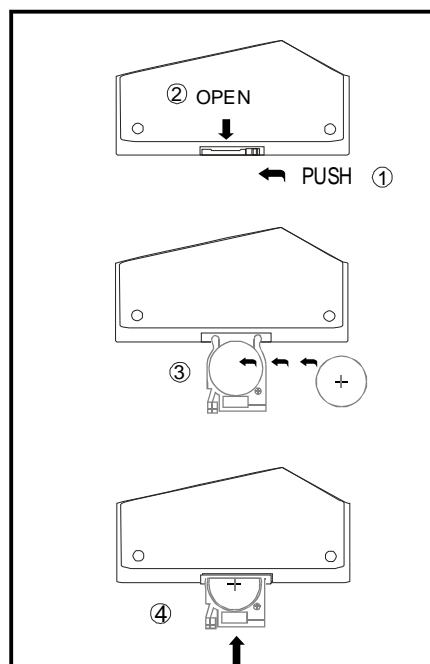

Fig 1

REMOTE CONTROL SENSOR



Fig 2

1.1 TV TYPE-It is for selecting the TV system according to the colour system of the TV.

Option:PAL
NTSC

1.2 TV DISPLAY - It is for selecting TV output mode.

Options: Normal /PS: Pan & scan mode
Normal/ LB: Letter box mode
Wide : 16:9 wide screen mode

1.3 ANGLE MARK - it is used to select whether or not the multi- angle icon is display on screen when a Multi-angle DVD disc is playing.

Options: On: Icon will be displayed
Off: Icon will be turned off

1.4 OSD LANG - It is used to choose the desired language for different user. In this player, you can choose English or other languages.

1.5 CAPTIONS - It is used to switch the caption ON/OFF when playing DVD disc.

1.6 SCREEN SAVER - when the player is not in use for 5 minutes, a running DVD logo will move across the screen to protect the TV CRT.

Options: On: Screen saver is enabled
Off: Screen saver is disabled

1.7 DEFAULT - It is used to reset to factory settings.

Viewing from different angle (DVD only)

Some DVDs may contain scenes which have been shot simultaneously from a number of different angles. For these discs, the same scene can be viewed from each of these different angles using the ANGLE button. Press ANGLE during play, number of angle being played will be displayed in the screen, press the button to change to different angles.

Initial Settings

- Once the initial programming is entered it is retained in memory until changed, the player can always be operated under the same conditions.
- The settings will be retained in the memory until the settings are changed even after setting the player to the standby mode.

Common procedure for initial settings

- Press SETUP button.
- Use the navigation buttons to select preferred item, and press ENTER button, each screen for setting the value is displayed. Then move the navigation button to set the item and press ENTER button to confirm the settings.
- Press SETUP button to close setup menu in any mode.
- Use left/right navigation button to switch to another main setup items

1. GENERAL SETUP

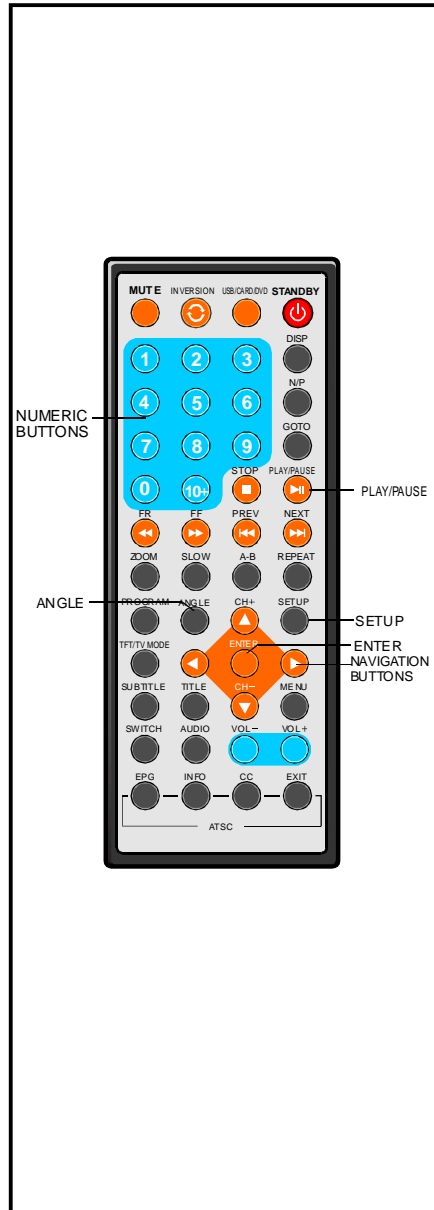
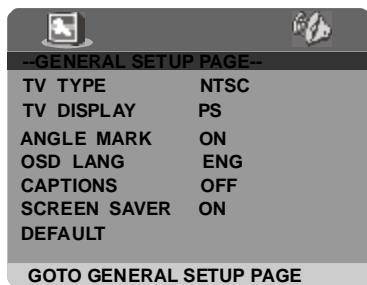

DVD OPERATIONS

Before enjoying DVD/Video CD/CD

The On-Screen menu language of the unit has been factory pre-set to English. If you want to change the menu language to other language, please refer to "DVD operations / Initial settings/ General setup / OSD lang". In the explanation below it is assumed that English has been selected as menu language.

Basic Play

- Switch on the DVD player (power switch is located on the right side of the unit.)
NOTE: 1). Make sure that all the connections including connections to AC adaptor, other AV equipment etc. have been completed before switching the POWER knob to the "ON" position.
 2). After switching the unit "OFF" wait several seconds before turning the unit back "ON". The unit may malfunction if the unit is switched back "ON" immediately after switching "OFF". If a malfunction occurs, switch the unit "OFF" and wait several seconds before turning it "ON" again.
- Press SWITCH button to set the unit in DVD mode.
- Push the open button to open the disc cover.

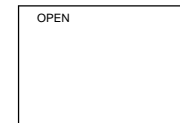

- Place a disc onto the disc compartment. Hold the disc without touching either of its surfaces, position it with the printed title side facing up, align it with the guides, and place it in its proper position.
- Close the disc cover, after closing the disc cover, play begins. The player starts to read the disc immediately.

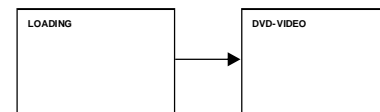

- When a menu screen appears on the TV, move the navigation buttons or press the numeric buttons to select preferred chapter number, then press ENTER button to play it.

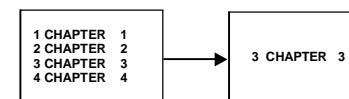

- Press NEXT or PREV button to play the next or previous chapter.
- To stop play and return to the menu screen, press TITLE button, or MENU button.

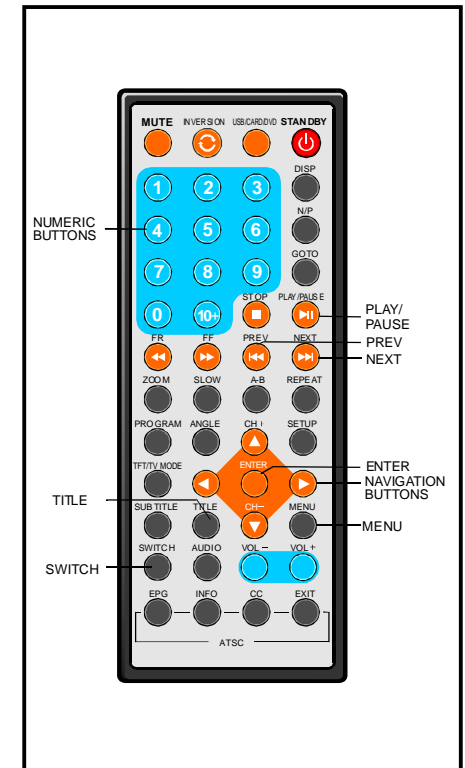

Stopping play

Press the STOP button to stop playing a disc.
NOTE: When player is stopped, the player records the point where STOP was pressed (RESUME function). Press PLAY again, playback will resume from this point. When the tray is opened or STOP is pressed again, the RESUME function will be cleared.

Skipping ahead or back

Skipping ahead

Press NEXT ►► button during play
 A chapter (DVD) or a track (Video CD/CD) is skipped each time the button is pressed.

Skipping back

Press PREV ◄◄ button during play
 A chapter (DVD) or a track (Video CD/CD) is skipped each time the button is pressed.

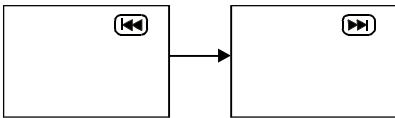

Fast forward (backward)

During playback, press FF ►► button or FR ◄◄ button to fast forward/rewind.
 Press PLAY button to resume normal play.



Pause or play

During playback, press PLAY/PAUSE ►| button, the play will be paused, To resume normal play, press PLAY button.

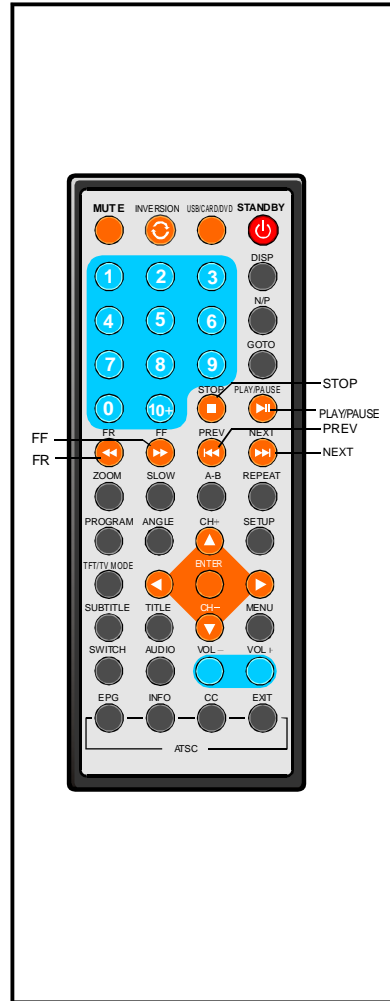
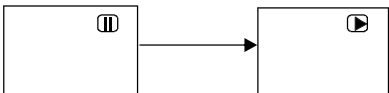

GO TO

Press GO TO button continuously to select the item you want to set and enter a time number, chapter number, track number etc. Accordingly, the disc will be played from the selected point.

Changing subtitle language (DVD only)

It is possible to change the subtitle language to a different language from the one selected at the initial settings. (This operation works only with discs on which multiple subtitle languages are recorded)

1. Press SUBTITLE button during play, the screen will display the current language.
2. Press SUBTITLE button continuously to change language or turn off.

NOTE: When no subtitles are recorded, press this button will not work.

CHANGING SUBTITLE LANGUAGE

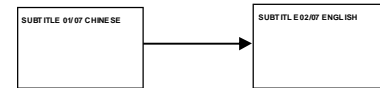

ZOOM play

This function allows you to enjoy a motion or motionless picture.

- Press ZOOM button when playing, the screen shows:

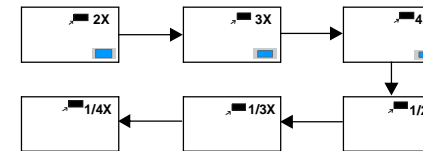

- Press NAVIGATION button to scroll across the enlarged picture.

Changing audio soundtrack language (DVD/VCD disc)

It is possible to change the audio soundtrack language to a different language from the one selected at the initial settings (This operation works only with discs on which multiple audio soundtrack languages are recorded).

- Press AUDIO button while playing DVD disc, the screen will display the number of current soundtrack languages, pressing the button again will change the language.
- Pressing AUDIO button while playing VCD disc will change audio output mode: Mono Left, Mono Right, Mix-mono and Stereo.

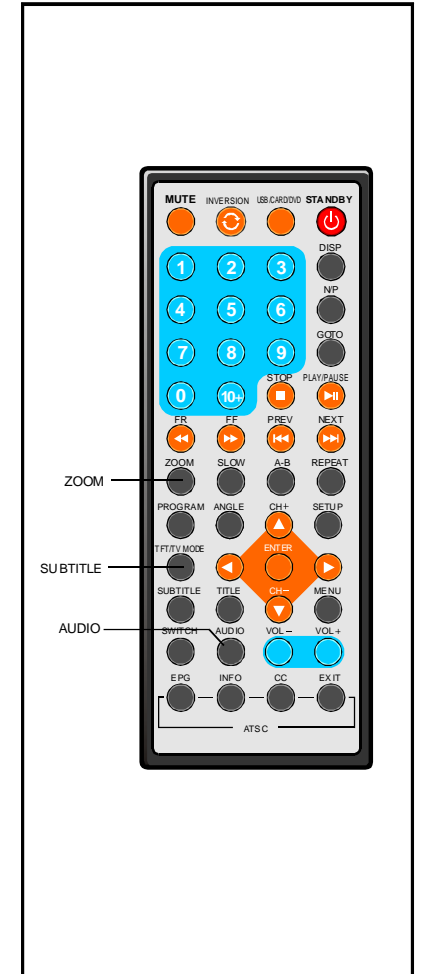

NOTE: When no soundtrack languages are recorded, pressing this button will not work. When the power is turned on or the disc is removed, the language heard is the one selected at the initial settings.



Repeat play

Press REPEAT button during play, it will repeat play one chapter or one title (for DVD disc), or repeat play track (for VCD/CD).

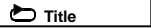
DVD DISC

-  Chapter Repeat a chapter
-  Title Repeat one title
-  All Repeat all

VCD/CD DISC (In the PBC OFF mode)

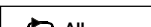
-  Track Repeat one track
-  All Repeat whole disc

A-B repeat play

Repeating sections between two specific points(A-B repeat)

1. Press A-B button during play at the point where repeat play is to be started(A).
2. Press A-B button at the point where repeat play is to be ended(B). Repeat play of the selection between points A and B starts.
3. Press A-B button once again to return to normal play.

TFT MODE

Press TFT/TV MENU button, the screen will display:

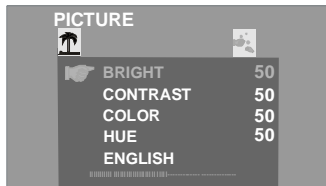

NOTE:The level of BRIGHT, CONTRAST, COLOR and HUE can be adjusted 0-100. The menu language can be changed among multi-languages.

1. Move the UP or DOWN navigation button to select BRIGHT, CONTRAST, COLOR, HUE, or ENGLISH item, then press the LEFT or RIGHT navigation button to adjust the level of the selected item.
2. Press TFT/TV MENU button again to enter OPTION page. Press UP or DOWN navigation button to select NORMAL or ZOOM item. Then press the LEFT or RIGHT navigation button to adjust. The NORMAL item can be adjusted between NORMAL and DOWN mode (to switch the picture between normal and vertical mode). And the ZOOM can be set to 16:9 or 4:3 mode.

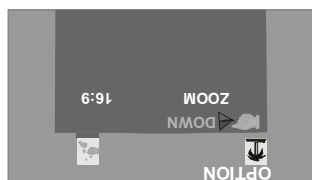
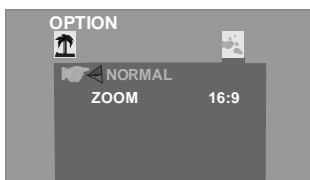

3. Press TFT/TV MENU button again to exit this page.

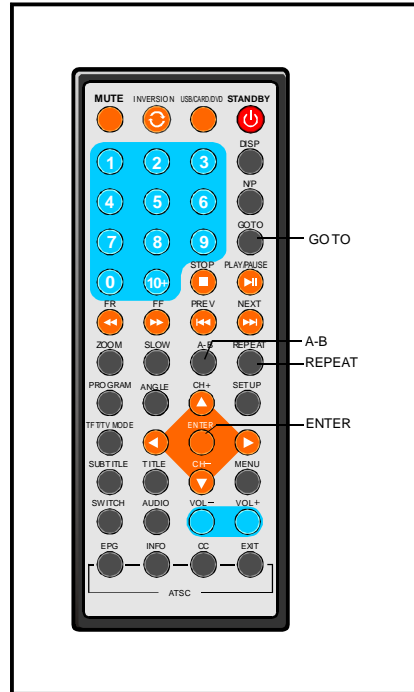

Slow-motion play(DVD/VCD)

Press the SLOW button during playback.

- 1) Plays the disc at a 1/2 of normal speed at first. Each time the button is pressed, the play speed becomes 1/4, 1/8, 1/16.
- 2) Press PLAY button, the unit will return to normal play.

Mp3 playback

1. Insert the disc containing the files in Mp3 format to be played and after several seconds, the monitor will display all the folders on the disc:

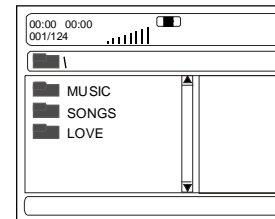

2. Select the folder you want to play using the navigation buttons and press the ENTER button to confirm.
3. The files in this folder are displayed and select the desired song by navigation buttons, then press the PLAY button to start playback.

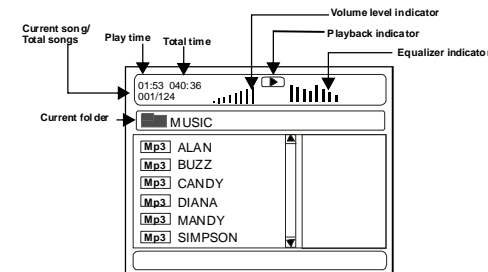

4. Press NEXT or PREV button to turn the current menu page to the next or previous menu page.
5. Press REPEAT button to change play mode.
 - SHUFFLE: all the files will be randomly sorted and played by the order.
 - RANDOM: randomly select any file to play.
 - SINGLE: play one file only.
 - REPEAT ONE: repeat one file.
 - REPEAT FOLDER: all the files in the folder will be played repeatedly.
 - FOLDER: all the files in the folder will be played.

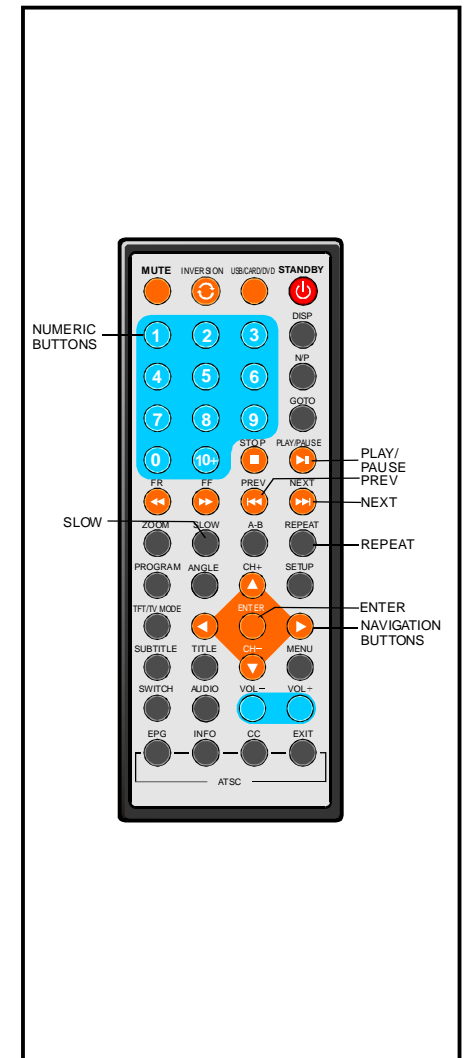

Mp4 playback

1. Insert the disc containing the files in Mp4 format to be played and after several seconds, the monitor will show all the folders on the disc:

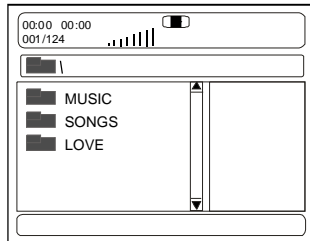

2. Select the folder you want to play using the navigation buttons and press the ENTER button to confirm.
3. The files in this folder are displayed and select the desired file by navigation buttons, then press the PLAY/PAUSE button to start playback.

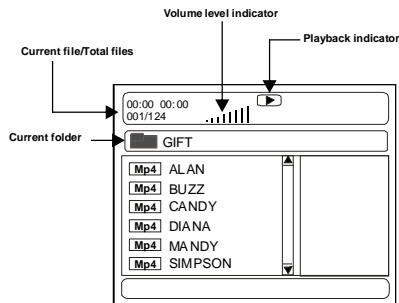

4. Press the NEXT or PREV button play the next or previous file.
5. Press the GO TO button to play the disc from the certain point as you want to.
6. Press the DISP button to display the playing information, the time remain, the time elapsed and so on.
7. Press REPEAT button to change play mode.
 - SHUFFLE: all the files will be randomly sorted and played by the order.
 - RANDOM : randomly select any file to play.
 - SINGLE: play one file only.
 - REPEAT ONE: repeat one file.
 - REPEAT FOLDER: all the files in the folder will be played repeatedly.
 - FOLDER: all the files in the folder will be played.

NOTE: The player can only play the disc with MPEG-4 format. The disc with other formats may not be played on this unit.

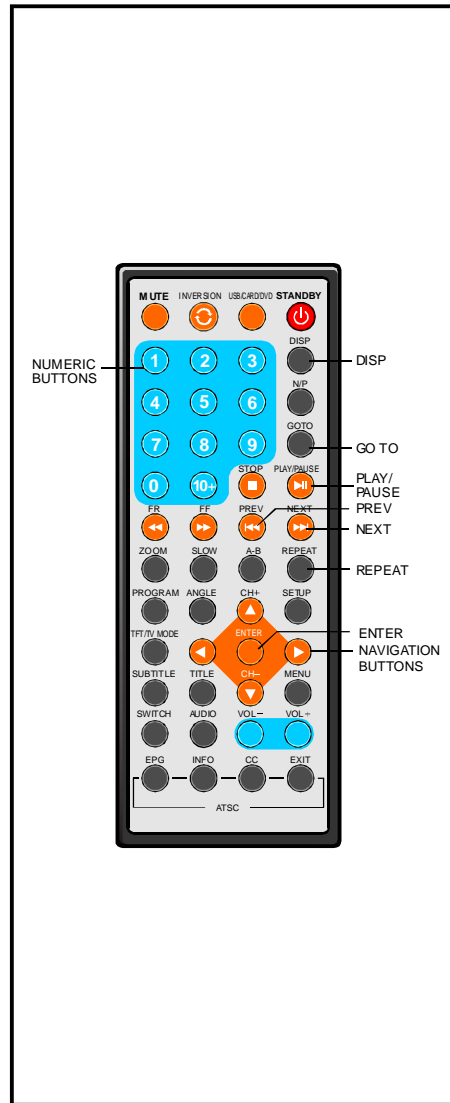

On screen display information

Press DISP button to display playing information.

DVD disc

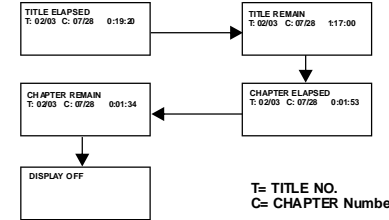

VCD disc

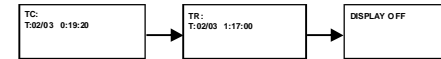

CD disc

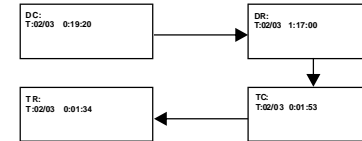

Program play

The player plays the files in an desired order.

1. Press PROGRAM button and the screen will display the program menu.

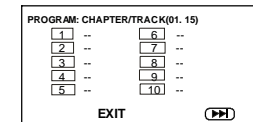

2. Press navigation buttons to choose memory index and then press ENTER button to start input. Enter desired titles/chapters numbers by using the numeric buttons. The selected titles/chapters are stored in the memory. Select ► on the menu to see the next page. Up to 20 tracks/chapters can be stored.

NOTE: Leading zero is not necessary. If the track number is more than 10, press the 10+ key first and then the unit digit.
Example: Track 12, press "10+" and then "2"
Track 21, press "10+" twice and then "1"
3. Select START on the menu and press ENTER button to start program play or select EXIT on the menu and press ENTER button to exit without program play.
4. To stop the program, press PROGRAM button select STOP on the menu, then press ENTER button.

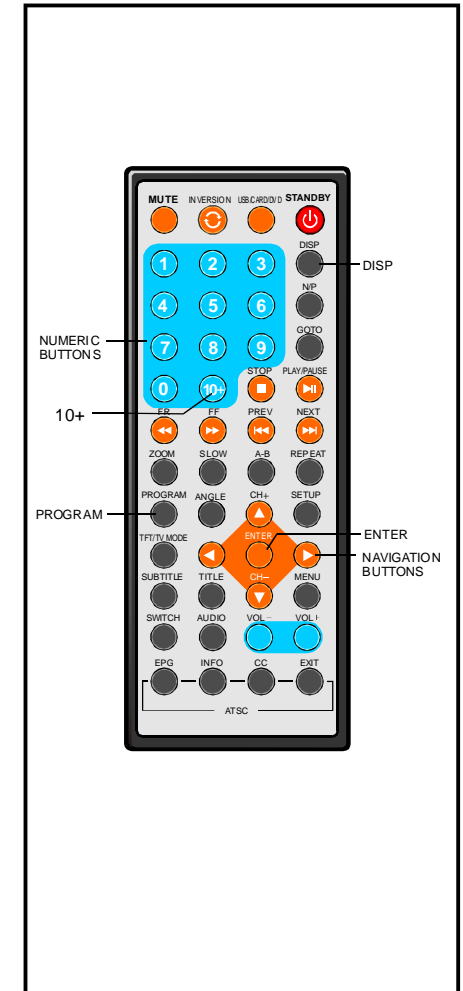

USB Playback

1. Insert USB containing the files in VCD/SVCD/ DVD/MP3/WMA/MP4/JPEG format to be played.
2. Press USB/CARD/DVD button to switch the unit in USB reader mode. Then the screen will display as following:

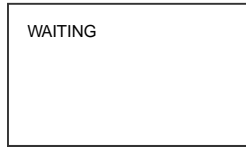

3. After several seconds, all the folders in the USB will display on monitor screen:

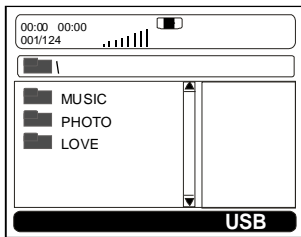

4. Select a folder you want to play using the navigation buttons and press the ENTER button to confirm.
5. The files in this folder are displayed and select the desired file by navigation buttons, then press the ENTER button to start to play.

IF YOU SELECT MUSIC FILE TO PLAY:

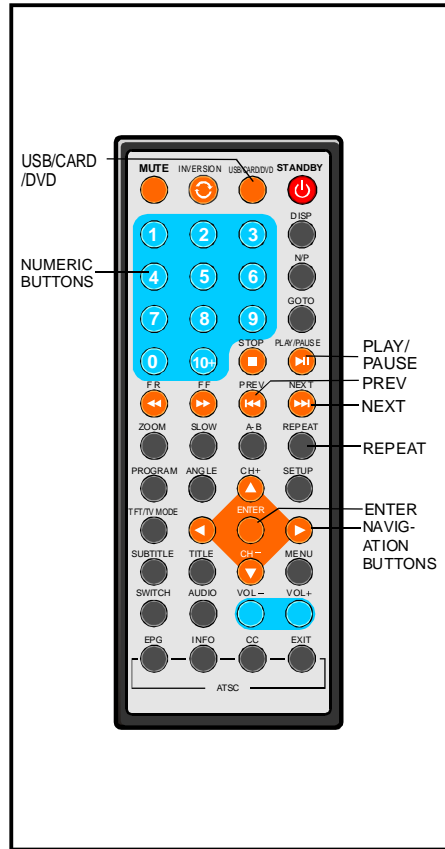
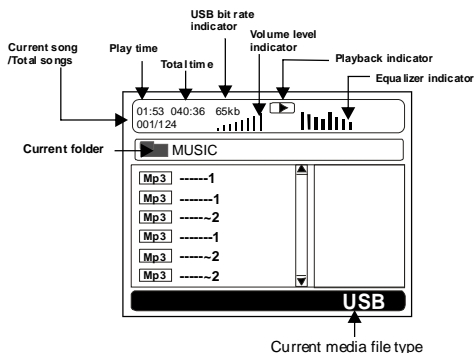

6. Press NEXT or PREV button to turn the current menu page to the next or previous menu page.
7. Press REPEAT button to set repeat playing mode.
 - SHUFFLE: all the files will be randomly sorted and played by the order.
 - RANDOM : randomly select any file to play.
 - SINGLE: play one file only.
 - REPEAT ONE: repeat one file.
 - REPEAT FOLDER: all the files in the folder will be played repeatedly.
 - FOLDER: all the files in the folder will be played.

JPEG CD

- For JPEG picture CD, select the folder you want to play using the navigation buttons and press ENTER button to confirm.
- The files in this folder are displayed and select your pictures by using the up/down navigation buttons and press ENTER button to start playback. A thumbnail of each picture will be displayed while you scrolling across the file name.



- Once a folder and file is selected, the picture is loaded onto the screen.



- NOTE:** The time to load and display picture depends on the file size of the pictures.
- During playback, press MENU button to return to folder selection or STOP button to enter preview mode.
 - Press REPEAT button to change play mode:
 - SHUFFLE: all the files will be randomly sorted and played by the order.
 - RANDOM : randomly select any file to play.
 - SINGLE: play one file only.
 - REPEAT ONE: repeat one file.
 - REPEAT ALL: repeat all files in the current folder.
 - FOLDER: all the files in the folder will be played.

Skip to next/previous picture

Press NEXT button to skip to the next picture or PREV button to skip to the previous picture. If no key is pressed for 5 seconds, it will skip to next picture automatically.

Rotating pictures

- Press RIGHT navigation button to rotate the picture clockwise.
- Press LEFT navigation button to rotate the picture counter-clockwise.

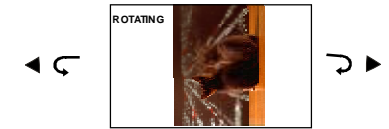

Flipping pictures

- Press UP navigation button to flip the picture vertically.
- Press DOWN navigation button to flip the picture horizontally.

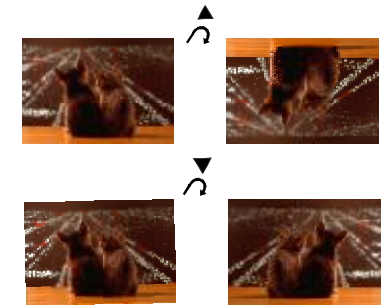

Picture Shrink/Zoom

- Press ZOOM button to enter the zoom mode
- Press FF or FR button to enlarge or shrink picture to 50%, 75%, 100%, 125%, 150% and 200% .



If the picture is enlarged, you may press the navigation buttons to pan across other portions of the picture.

